

Adaptor

Metric to Metric

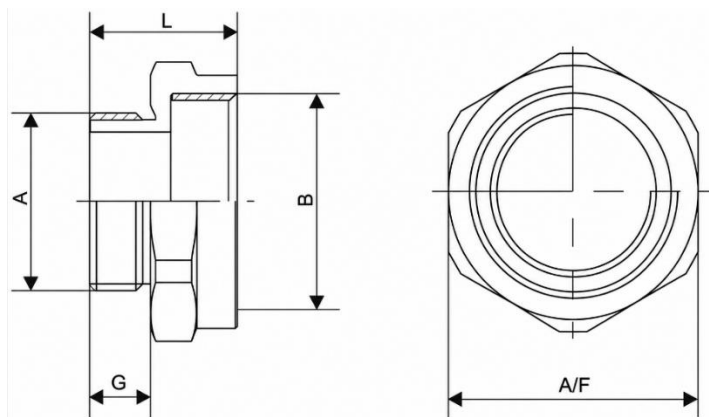

MM-EX-AD5M5M B2 (M50 to M50)



Reducer

IP Rating	IP68
IECEX Certificate No.	IECEX PRE 20.0123X
ATEX Certificate No.	Presafe 20 ATEX 24571X
EAC Certificate No.	RU C-IN.AA71.B.00212/20
PESO Certificate No.	P538496/2
Thread Type	Metric to Metric
Protection Type	Ex d, Ex e, Ex t
Material	Brass Nickle Plated (BNP)
Ambient Temperature	IECEX/ATEX-55°C ≤ Ta ≤ +160°C EAC-60°C ≤ Ta ≤ +130°C

Metric to Metric Thread

CODE	MM-EX-AD5M5M B2 (M50 to M50)
A	M50X1.5
B	M50X1.5
L	34
A/F	16
G	55

* Degrees of protection (IP Code) : IP66 / IP68 (1.5 meter, 2 Hours)