

Adaptor

NPT to NPT

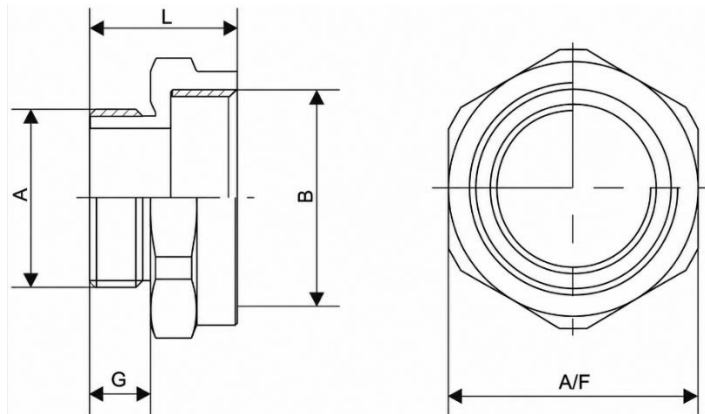

MM-EX-AD5N6N B2 (1 1/2"NPT to 2"NPT)



Reducer

IP Rating	IP68
IECEX Certificate No.	IECEX PRE 20.0123X
ATEX Certificate No.	Presafe 20 ATEX 24571X
EAC Certificate No.	RU C-IN.AA71.B.00212/20
PESO Certificate No.	P538496/2
Thread Type	NPT to NPT
Protection Type	Ex d, Ex e, Ex t
Material	Brass Nickle Plated (BNP)
Ambient Temperature	IECEX/ATEX-55°C ≤ Ta ≤ +160°C EAC-60°C ≤ Ta ≤ +130°C

NPT to NPT Thread

CODE	MM-EX-AD5N6N B2 (1 1/2"NPT to 2"NPT)
A	1 1/2"
B	2"
L	54
A/F	27
G	65

* Degrees of protection (IP Code) : IP66 / IP68 (1.5 meter, 2 Hours)