

Reducer

Metric to Metric Thread

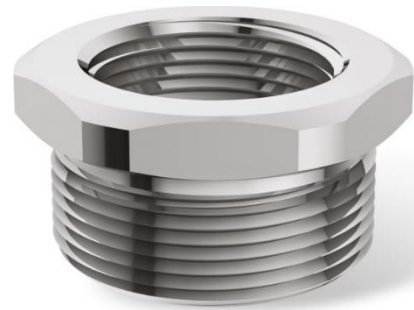

MM-EX-RD3M1M B2 (M32 to M20)



Reducer

IP Rating	IP68
IECEX Certificate No.	IECEX PRE 20.0123X
ATEX Certificate No.	Presafe 20 ATEX 24571X
EAC Certificate No.	RU C-IN.AA71.B.00212/20
PESO Certificate No.	P538496/1
Thread Type	Metric to Metric
Protection Type	Ex d, Ex e, Ex t
Material	Brass Nickle Plated (BNP)
Ambient Temperature	IECEX/ATEX-55°C ≤ Ta ≤ +160°C EAC-60°C ≤ Ta ≤ +130°C

Metric to Metric Thread

CODE	MM-EX-RD3M1M B2 (M32 to M20)
A	M32X1.5
B	M20X1.5
L	22
A/F	36
G	16

* Degrees of protection (IP Code) : IP66 / IP68 (1.5 meter, 2 Hours)